

FOREST[®]

DRAPERY HARDWARE



CKS[®]
Corded Klick System

- ① CKS Track
- ② KS Carrier
- ③ CKS Master Carrier Overlap
- ④ CKS Master Carrier Underlap
- ⑤ CKS Pulley

Mounting Brackets

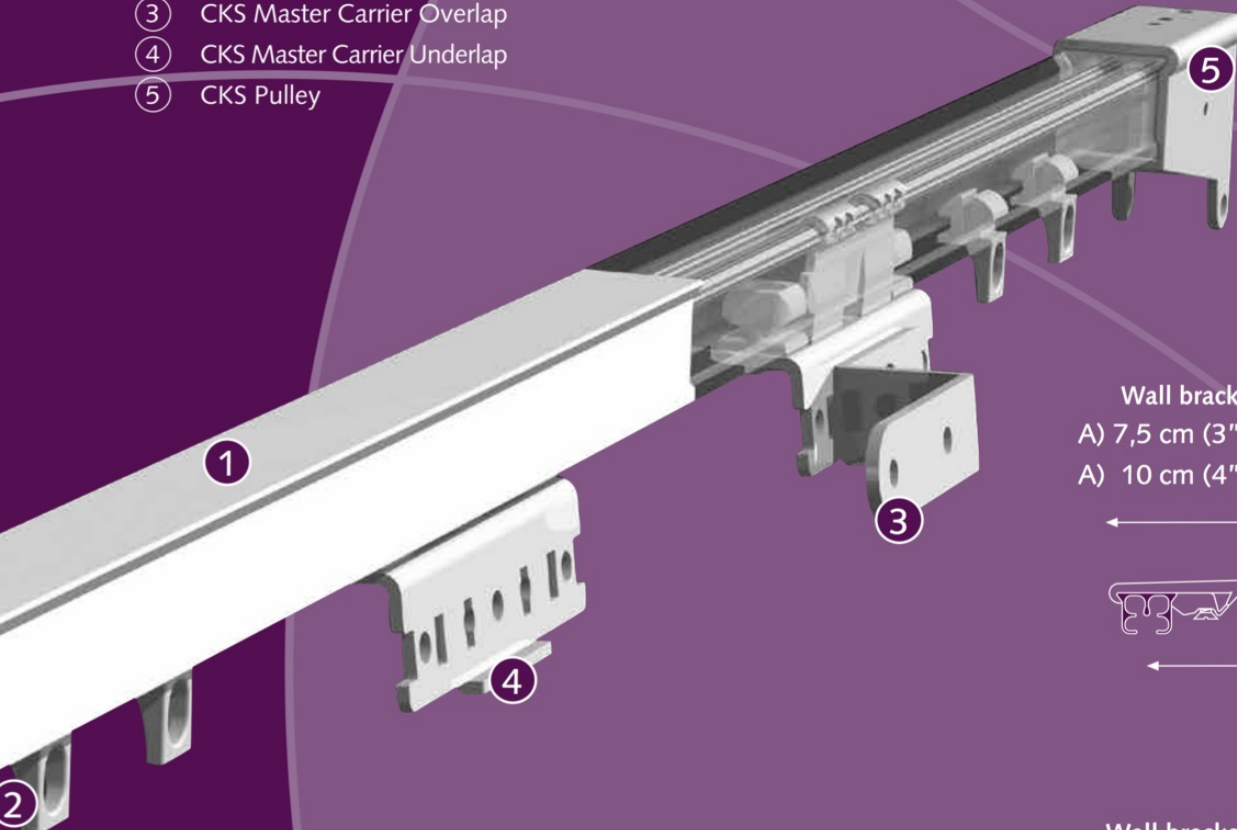

⑤ Ceiling Bracket



Wall bracket aluminium single
 A) 7,5 cm (3''), B) 6,3 cm (2,5'')
 A) 10 cm (4''), B) 8,8 cm (3,5'')

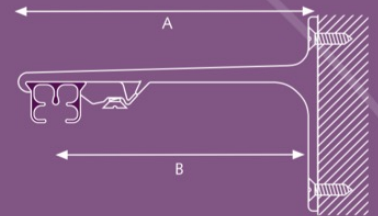

Wall bracket aluminium double
 A) 15 cm (6''), B) 9,2 cm (3,6''), C) 4,5 cm (1,8'')
 A) 20 cm (8''), B) 9,2 cm (3,6''), C) 9,5 cm (3,7'')

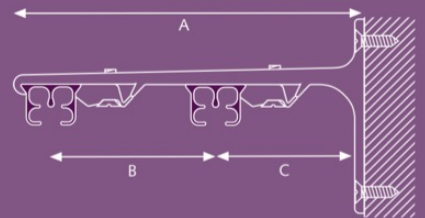

Wall bracket
 3,5 cm (1,4''), 6 cm (2,4'')

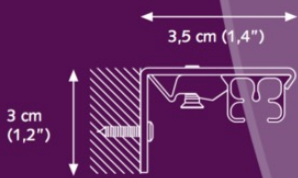

A) Min. 10 cm (4'')



A) Min. 15 cm (6'')



Wall bracket aluminium triple
 25 cm (10'')

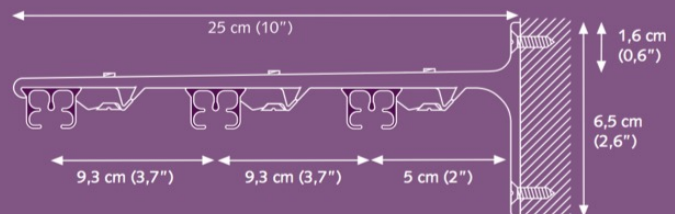

Other brackets are available. Brackets need to be placed every 60 cm (24'').

CKS[®] Corded Klick System

Product information

- Highly efficient cord traversing system with separate internal cord channels; preventing cord sag and eliminating cord tangle.
- Quick installation with "Smart Klick" brackets for wall and ceiling applications.
- Bendable; it can be curved and reverse curved by using a 10 cm (4") radius or continuous curved.
- Heavy duty clickable carriers -UV protected - for smooth and easy traversing. Offset shape for straight hanging pleats.
- Can also be used for ripplefold or accordiafold drapery systems.
- Maximum fabric weight: ± 6 kg per meter (4,5 LBS per ft.).
- Colours available: white and silver.
- Available lengths: 4 meter (13'1"), 5 meter (16'4"), 6 meter (19'8").
- Track finish: chromated powder coated with a factory applied patented dry lubricant.
- Limited lifetime warranty.

For use in

Hotels - offices - residences - boats - campers - planes or any location where an efficient cord traversing system is required.

Applications

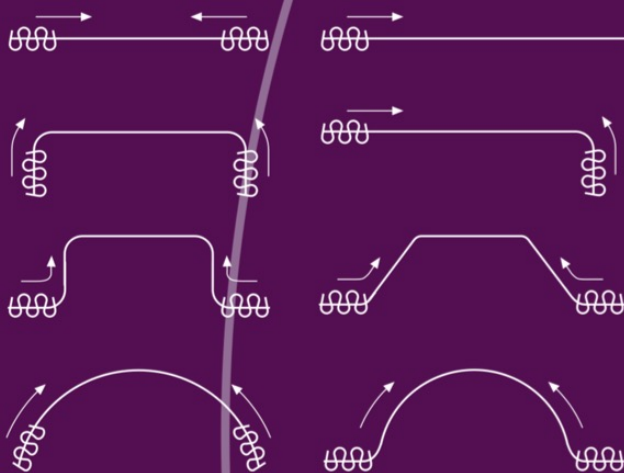

Bending and assembly instructions available on request

Bending/ curving

The track can be curved and reverse curved using a 10 cm (4") radius. Continuous curving can easily be done using the continuous curver or the electric powered bender.



Profile

- Shown actual size 1:1
- Aluminium Extrusion
- Weight: 202 grams per meter (2.17 ounce per ft.)
- Dimensions: 14 mm x 20 mm (0,6" x 0,8").

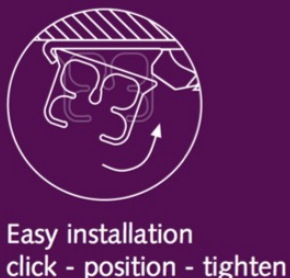
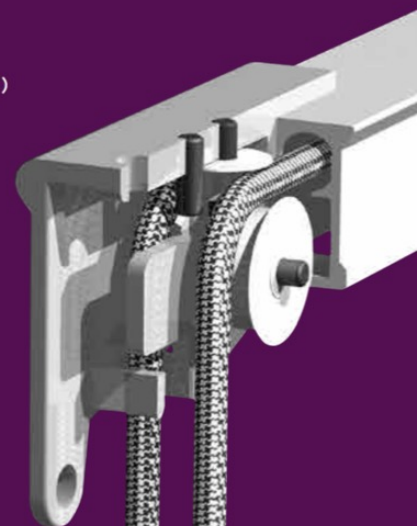
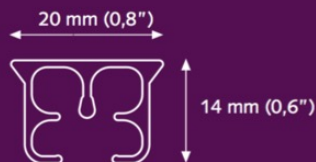

Colours available from stock:

Complete the art.nr. with the indicated colour-code

**01 White 06 Black
03 Silver**

Other colours can be delivered on request.

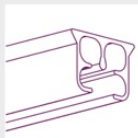

CKS Track 15010..00 cm
20/bundle
Aluminium extrusion, powder coated, lubricated, Colours: 01, 03 & 06.
Available lengths: 4 m. (13'1"), 5 m. (16'4"), 6 m. (19'8").
Silver only in 5 meter length

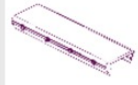

KS/DS/CKS Track Joiner 1018401010
Available in the colours: 10/box
01, 03 and 06.



Carrier 10100..000
500/box
"Clickable", offset, constructed of UV resistant plastic. 10 Carriers on a break-away strip. Can be clicked in after installation. Colours: 01, 03 & 06.

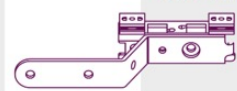

CKS Master Carrier Overlap 15157..000
25/box
Will go through curves.
Available in the colours: 01, 03 & 06.

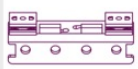

CKS Master Carrier Underlap 15156..000
25/box
Will go through curves.
Available in the colours: 01, 03 & 06.

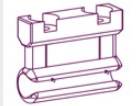

CKS Cord Connector 1530301000
100/box
Connects cord to the CKS Master Carrier. Colours: 01

CKS Cord Connector Half 1530311000
100/box
Connects cord to the CKS Master Carrier. Colours: 01



CKS Pulley 15301..000
25/box
Reversible, for two way draw.
Available in the colours: 01, 03 & 06.

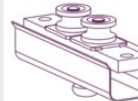

CKS Center Pulley 1530101020
25/box
to join two equal sized tracks in the middle, to create lengths > 6 meter. (19' 18")

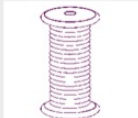

Traverse Cord 1030401000
250 mtr/roll
Nylon drapery cord designed for strong smooth slide, Ø 3.5 mm (0,14")
16 ply. White

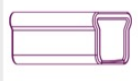

CKS End Pulley White Short 1530101011
25/box
Especially for one-way closing of the curtain. Available in white & silver.



Tension Pulley 1030501000
25/box
Plastic, white.



Cord Weight 3030601000
20/box
Plastic, available in white only



Smart Klick Ceiling Bracket 10182..000
100/box
"Klicks" onto track, powder coated.
Install with counter sunk head screw 4 mm.

Inclusive Covercap
white 1018201001
silver 1018203001
brown 1018205001
black 1018206001



Smart Klick Wall Bracket 50/box
3,5 cm (1³/₈") and 6 cm (2³/₈").
"Klicks" onto track, powder coated. 10202..035
One screw attachment.

For light weight use only. 10202..060

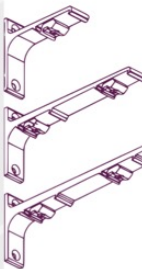

Aluminium Wall bracket 10203.. ...mm
Smart klick, powder coated.

7,5 cm single (3") 20/box

10 cm single (4") 20/box

15 cm double (6") 15/box

20 cm double (8") 15/box

25 cm triple (10") 10/box



Compact Bending Tool 105000000
For 20 mm (0,8") KS/CRS 1/box

KS/CKS Bending Wheel All-in 105100000
For 20 mm (0,8") KS/CRS incl. strips 1/box



Continuous Curver 1060200000
Add on tool for the Compact Bending tool. Designed to create continuous curves and arches in any radius. Includes bending strip. For CKS/KS track only. 1/box

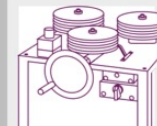

Electric Powered Bender 1060500000
Available in 230V or 115V, to create continuous curves and arches. Minimum radius 50 cm (20"). 1/box



CKS Replacement Bending Strip 1560100000
For Compact Bending Tool. 1/each
Length of strip: 60 cm (23")

For Continues Curver / electric bender. Length of strip: 7 mtr. (23") 1560300000
1/each



KS/CKS Bending Wheels 1060700000
For electric powered bender. Complete set of 3 wheels. 1/set
For CKS/KS track only.



Electric Powered Railcutter 1/each
230 Volt EU 1061100000
115 Volt USA 1061200001
230 Volt UK 1061200002

Replacement blade 1061200000
For electric powered railcutter. 1/each

Distributor:



FOREST
DRAPERY HARDWARE